

Figure1. Drawing and dimensions

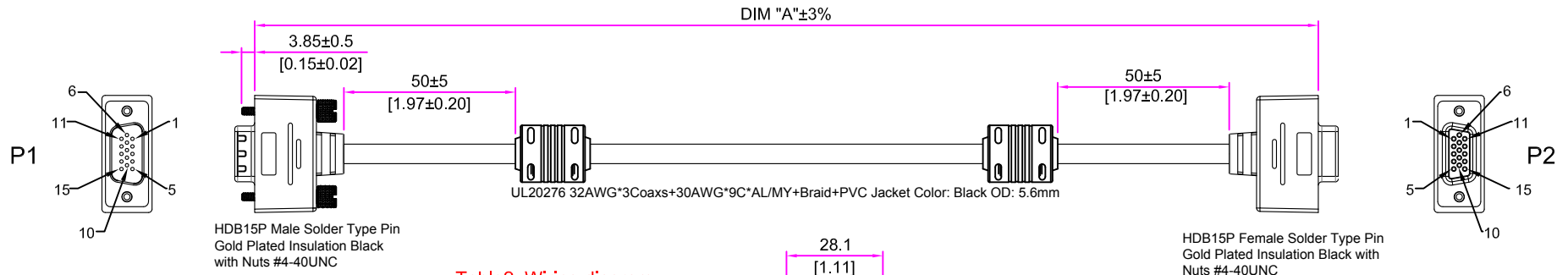
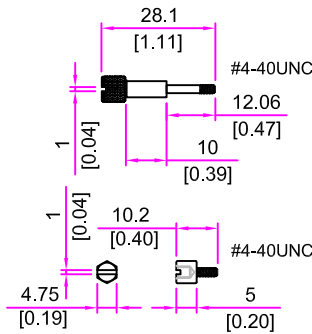
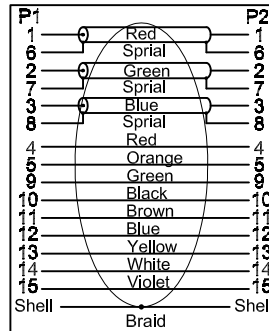

Table 1.

No.	OCP P/N.	DIM "A"
1	61-00122-01	305mm (12")
2	61-00122-02	610mm (24")
3	61-00122-03	915mm (36")
4	61-00122-04	1220mm (48")
5	61-00122-06	1830mm (72")
6	61-00122-050	15250mm (600")

Table2. Wiring diagram



2pcs per Zip PE Bag

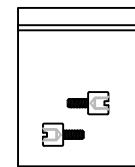

2pcs per Zip PE Bag

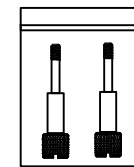

1pc per Zip PE bag

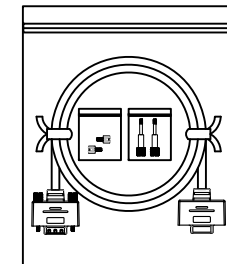

ELECTRICAL CHARACTERISTICS:

- Contact resistance:
  - 1.1. < 2 Ω (for length < 3m),
  - 1.2. < 10 Ω (for length 10~16m)
- Insulation resistance: 500V DC, >20MΩ
- All harnesses must be tested for continuity and shorts.

NOTES:

- All the materials must meet RoHS compliance.

Recommended panel cut out size:

Rev. ⚠

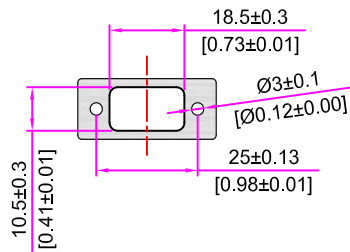

UNLESS OTHERWISE SPECIFIED:  
DIMENSIONS ARE IN MILLIMETERS [INCH]  
TOLERANCES ARE:  
.X ±0.5 ANGULAR ±0.5°  
.XX ±0.20  
.XXX ±0.100

DRAWN BY Ronald Mo  
CHECKED BY Kk So  
APPROVED BY O. Acuña



CONNECT WITH CONFIDENCE

PROPRIETARY AND CONFIDENTIAL

THE INFORMATION CONTAINED IN THIS DRAWING IS THE SOLE PROPERTY OF OCP CHINA. PARTIAL OR TOTAL REPRODUCTION WITHOUT THE WRITTEN PERMISSION OF OCP CHINA IS PROHIBITED.

OCP P/N: see table 1	TITLE: HDB15P Male to HDB15P Female
CUSTOMER P/N:	PROJECT NO.:
CUSTOMER REV/LEVEL:	DRAWING NO.:
CUSTOMER NAME:	REV.: B

UNITS: mm / inch SCALE: Free SIZE: A4 SHEET 1 OF 1

Figure1. Drawing and dimensions

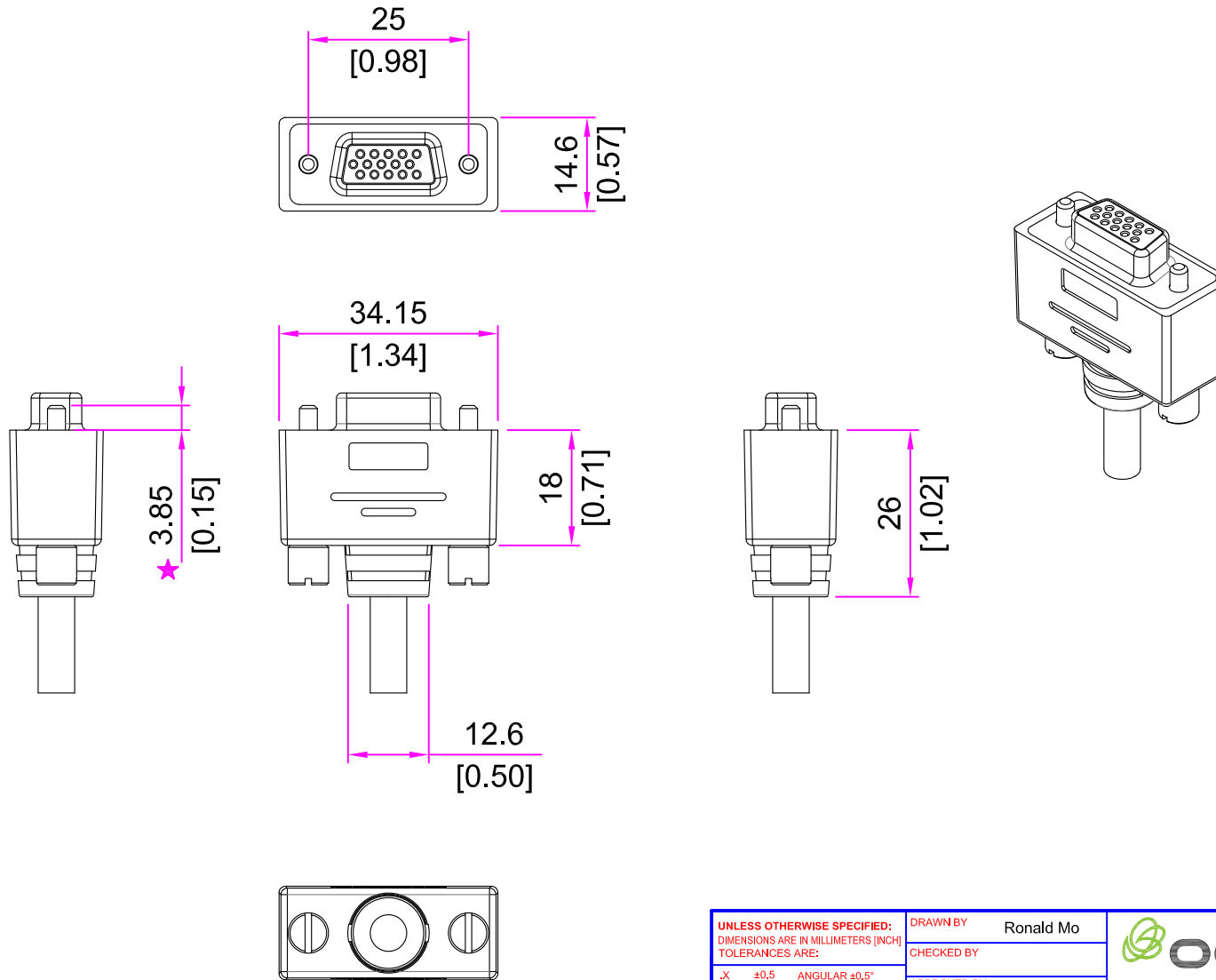

NOTES:  
1. The dimension with "★" shall be strictly controlled.

UNLESS OTHERWISE SPECIFIED: DIMENSIONS ARE IN MILLIMETERS [INCH] TOLERANCES ARE:	DRAWN BY	Ronald Mo	 CONNECT WITH CONFIDENCE			
	CHECKED BY					
.X ±0.5 ANGULAR ±0.5° .XX ±0.20 .XXX ±0.100	APPROVED BY	O. Acuña	TITLE:			
PROPRIETARY AND CONFIDENTIAL THE INFORMATION CONTAINED IN THIS DRAWING IS THE SOLE PROPERTY OF OCP CHINA. PARTIAL OR TOTAL REPRODUCTION WITHOUT THE WRITTEN PERMISSION OF OCP CHINA IS PROHIBITED.			HDB15P male or female overmold			
			OCP P/N:		PROJECT NO.:	
			CUSTOMER P/N:		DRAWING NO.:	
			CUSTOMER REV.LEVEL:		REV.: B	
CUSTOMER NAME:			UNITS: mm / inch	SCALE: Free		
			SIZE: A4	SHEET 1 OF 1		